

RAIDON

SafeTANK
GR5640

User Manual

» SafeTANK GR5640 User Manual	1
1. Environmental Requirements	1
2. Package Contents and Product Views	1
3. Hardware Requirements and Precautions	3
4. Hardware Installation Procedure	4
5. Description of Front Panel Operation and LCD Information	5
6. Support DisplayPort	16
7. Support USB Power Delivery (GR5640-SB31+/GR5640-SBA31+)	16
8. Replacement of Malfunctioning Drive and Data Rebuild Instructions.....	17
9. System Temperature Overheat and Fan Failure Management.....	17
10. Install The Operation System Into This Device	18
11. Frequently Asked Questions.....	23
» SafeTANK GR5640 產品使用說明.....	24
1. 環境需求	24
2. 產品外觀及包裝內容	24
3. 硬體需求與注意事項	26
4. 硬體安裝	27
5. 前面板操作及 LCD 訊息說明	28
6. 支援 Display 埠.....	39
7. 支援 USB Power Delivery (GR5640-SB31+/GR5640-SBA31+).....	39
8. 故障硬碟更換步驟及資料重建功能說明	40
9. 系統過熱與風扇故障狀況排除.....	40
10. 外接磁碟安裝作業系統.....	41
11. 常見問題	46

Introduction

Thank you for choosing the RAIDON product. This manual will familiarize you with the RAIDON GR5640 product. We recommend reading through this manual before using the RAIDON GR5640 product. The information provided in this manual was checked before publication, but the actual product specifications may have changed before shipping; Latest product specifications and updates can be found at www.RAIDON.com.tw. No separate notifications will be provided by our company. If you would like to receive the latest RAIDON product information, manuals, and firmware, or have any questions regarding RAIDON products, please contact your local supplier or visit www.RAIDON.com.tw for more information.

All product-related content in this manual are copyrighted by RAIDON TECHNOLOGY, INC.

1. Environmental Requirements

Operating Temperature: 0 ~ 40 °C (32 ~ 104 °F)

Storage Temperature : -20 ~ 47°C (-4 ~ 116 °F)

Line Voltage : 100 ~ 240V AC

2. Package Contents and Product Views

Open the package and you shall find the following parts :

GR5640-SBA31+ product x 1 (with removable drive tray enclosed x 4)	GR5640-SB31+ product x 1 (with removable drive tray enclosed x 4)	GR5640-SB31A product x 1 (with removable drive tray enclosed x 4)
USB 3.2 C to C cable x1	USB 3.2 C to C cable x1	— —
USB 3.2 C to A cable x1	— —	USB 3.2 C to A cable x1
e-SATA Cable x 1	e-SATA Cable x 1	e-SATA Cable x 1
Power Cable x1	Power Cable x1	Power Cable x1
Quick Installation Guide x1	Quick Installation Guide x1	Quick Installation Guide x1
Screws & Ejector pins	Screws & Ejector pins	Screws & Ejector pins

- Please check the product and accessories for any defect or missing parts. If you have any questions, please contact your product supplier.
- Please visit the official website - Download page (<https://www.RAIDON.com.tw/RAIDON2016/download.php>) to download drivers and other related resources.

Product View

Front View

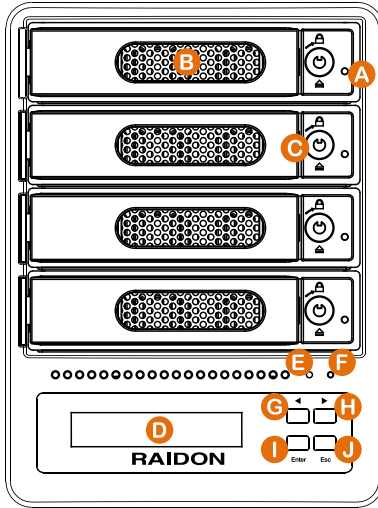

- A. HDD access light
- B. HDD enclosure handle
- C. HDD tray key lock
- D. LCM display
- E. System status light
- F. Power status light
- G. UP button
- H. DOWN button
- I. ENTER button
- J. ESC button

Rear View

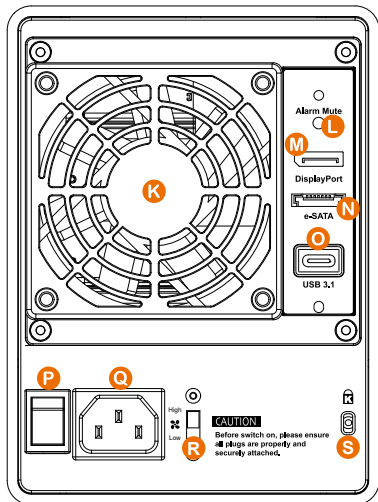

- K. Fan
- L. Mute button
- M. Display port
- N. e-SATA port
- O. USB 3.1 port
- P. Power main switch
- Q. Power socket
- R. Fan speed switch
- S. Anti-theft lock

LED Indicators :

Status	Power status light	System status light	HDD LED		Buzzer	
			RAID	JBOD	RAID	JBOD
No HDD	Blue light always on	— —	— —		— —	
Access	Blue light always on	— —	Blue light flashing		— —	
Disk Idle	Blue light always on	— —	Blue light always on		— —	
Rebuilding - Source	Blue light always on	— —	Blue light flashing	— —	— —	
Rebuilding - Target	Blue light always on	— —	Purple light flashing	— —	— —	
Fan Failed	Blue light always on	Red light always on	Blue light always on		YES	
Over Temp	Blue light always on	Red light always on	Blue light always on		YES	

3. Hardware Requirements and Precautions

- When connected to the computer system, it's prohibited to remove, insert or swap the hard drive while data transfer is being performed.
- It's prohibited to change the positioning of the drives once the initial installation has been completed as the changes made to the drive positions may destroy the RAID formation.
- The product needs to be restarted after adding or changing the RAID mode, and the update is guaranteed to be the new RAID mode.
- When the Notebook which support USB PD function is only connected to GR5640-SB31+/GR5640-SBA31+, GR5640-SB31+/GR5640-SBA31+ can provide up to 24W (12V/2A) power supply, but if then connected to other power supply such like the original Notebook power supply, Notebook will automatically judge which one will be the main power source, usually the one which can provide more Wattage will be. At this time, GR5640-SB31+/GR5640-SBA31+ may be interrupted and re-identified by the Notebook. Therefore, before connecting to other power supplies, please make sure that there are no data accessed between Notebook and GR5640-SB31+/GR5640-SBA31+.
- GR5640-SB31+/GR5640-SBA31+ can only provide 24W at most, which is different from the original Notebook power supply. It mainly to extend the Notebook's usage time. Take Macbook Pro 13" as an example, the original power supply is 60W, assuming it take 2 hours for it to fully charge the battery , use GR5640-SB31+/GR5640-SBA31+ might need three times time. Therefore, if user need to use Notebook for a long time, it is recommended to connect the original power supply first before connect GR5640-SB31+/GR5640-SBA31+.
- Whenever turning off or unplugging the GR5640-SBA31 from your computer system becomes necessary, always remember to safely remove it from your operating system first.
- It is highly recommended for users to back up important data contained within the GR5640-SBA31 unit on a regular basis or whenever the user feels necessary to a remote or a separate storage device. RAIDON will not be responsible for any lost of data caused during the use of the unit or the recovery of the data lost.

4. Hardware Installation Procedure

Please follow the instructions below to complete the hardware installation.

1. Place the system on a stable surface. Ensure that it is well ventilated without blockage to the vent and kept away from areas near water and damage prone areas.
2. Use the key included in the kit to insert the key hole and turn 90 degrees to the left, then gently press the locking extractor latch to open it and remove the hard drive.



3. For 3.5" HDD/SSD, please secure it by use six the larger screws included in the accessory kit. For 2.5" HDD/SSD, please secure it by use four the smaller screws included in the accessory kit.

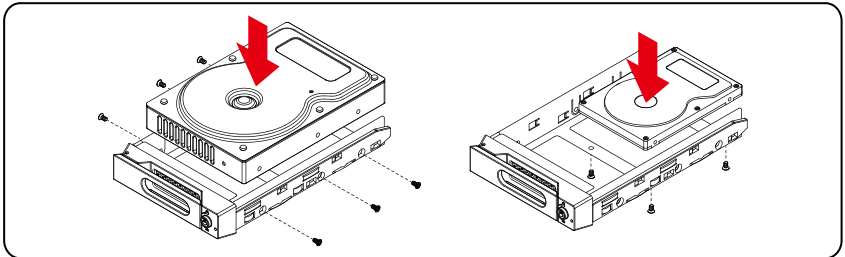

Note: Please avoid using hard disk drives from different manufacturers or different models from the same manufacturer as this may impact system performance.

4. When the hard drive installation has been completed, insert the hard drive tray into the system horizontally and secure the latch into place.
5. Connect the AC power cable to the GR5640 and then plug the AC power to the wall socket. Boot-up the unit.
6. Set the storage mode using the LCD and buttons on the front (please refer to section 5 for front panel and LCD information).
7. Connect the cable to the PC and the GR5640 port.
8. After boot-up, your operating system will automatically detect the storage capacity of your hard drives. Please follow the operating system instructions to configure and format your drives. The formatted drives can be configured for the RAID setup.

5. Description of Front Panel Operation and LCD Information

Front Panel Operation:

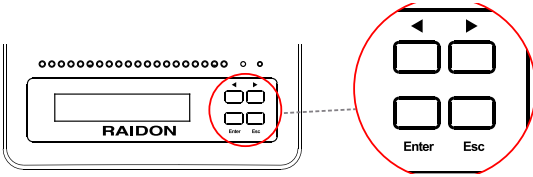

Enter: Enter to next level or Confirm
 Esc: Back to next level or Cancel
 Up / Down : Select Items

- Users can set the RAID mode using the LCM and buttons on the front. The default is JBOD mode. With the "Quick Setup" feature, users can quickly change other RAID modes.
- Please refer to LCD Information as below for other setting:

Level 0	Level 1	Level 2	Level 3	Level 4	
External 4BAY HARDWARE RAID	Quick Setup	Create One RAID	RAID 0/ RAID 5	Select Disk	
		Delete All RAID			
	Disk Manager	Identify Disk		Disk 1	Check Disk LED
				Disk 2	Check Disk LED
				Disk 3	Check Disk LED
				Disk 4	Check Disk LED
		Show Disk Info	< Disk Info >		
	RAID Manager	Identify RAID	Select RAID		
		Create RAID	RAID 0 / RAID 5	Select Disk	
		Delete RAID	Select RAID		
		RAID Info	-- --		
		Change RAID Pwd	< Password > for RAID Setup		
		Rebuilding Priority	Highest/High/Medium/Low/Lowest		
	System Manager	System Info	Firmware Version		
		Changhe Password	< Password > for System Info		
		Logout From Menu	< Y or N >		
		Alarm Control	Mute the Buzzer		
		Hardware Monitor	Voltage Monitor	< 3.3V / 5V / 12V >	
	Temp. Monitor		< Temp. >		
	Fan Monitor		< Fan Speed / Fan Level >		

The following is the display status set for the first time:

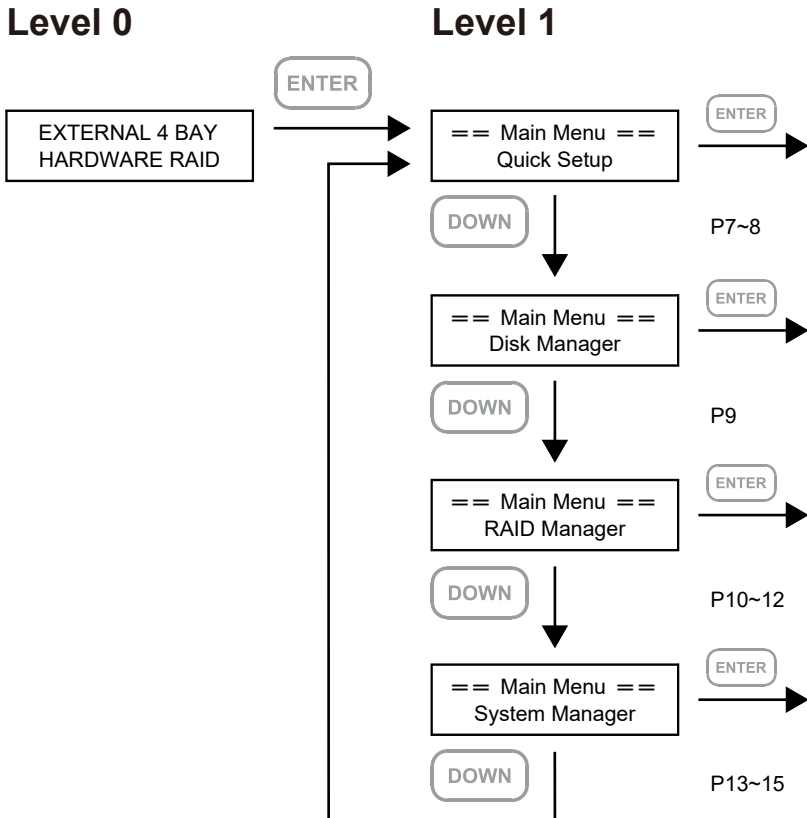

Level 1

Level 2

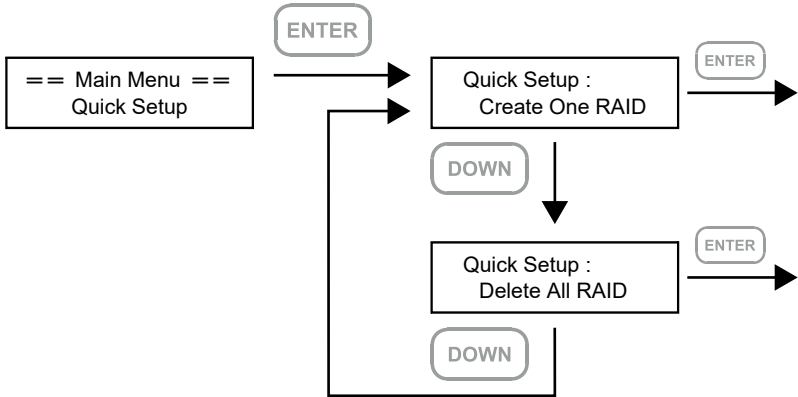

Level 2

Level 3

Level 4

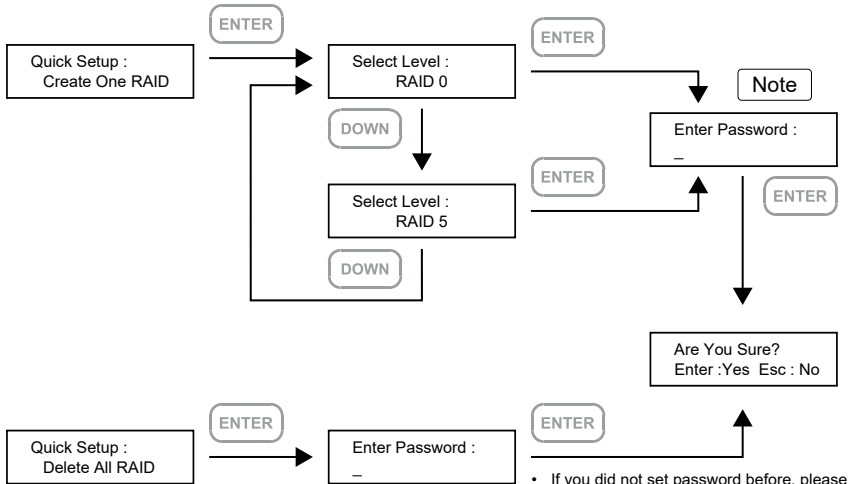

- If you did not set password before, please press "ENTER" to go to next step.

Note 1. If you don't want to set password, please press "ENTER" to go to next step.

Note 2. If user forgot the password, it will not be allowed to access the data from the storage or write new data into it. RAIDON will not be held liable for the damage or loss of data you stored on the storage.

Level 1

== Main Menu ==
Disk Manager

Level 2

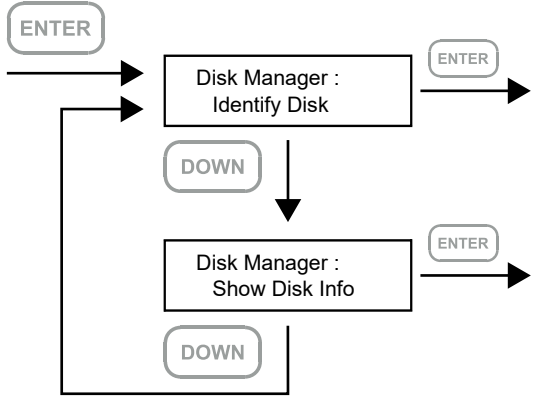

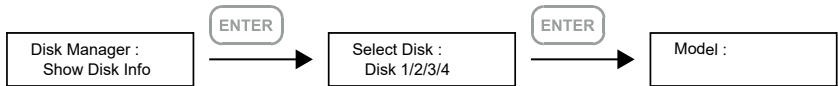
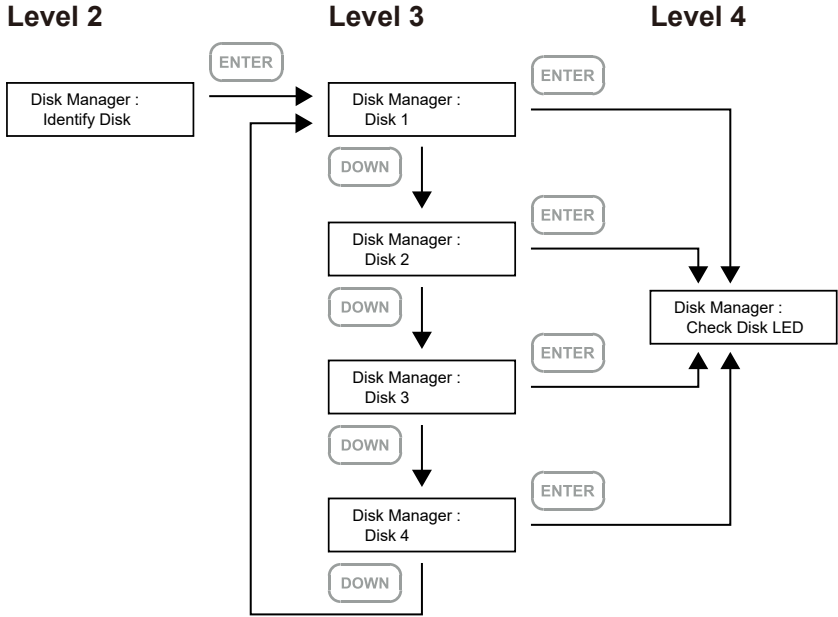

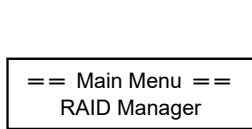
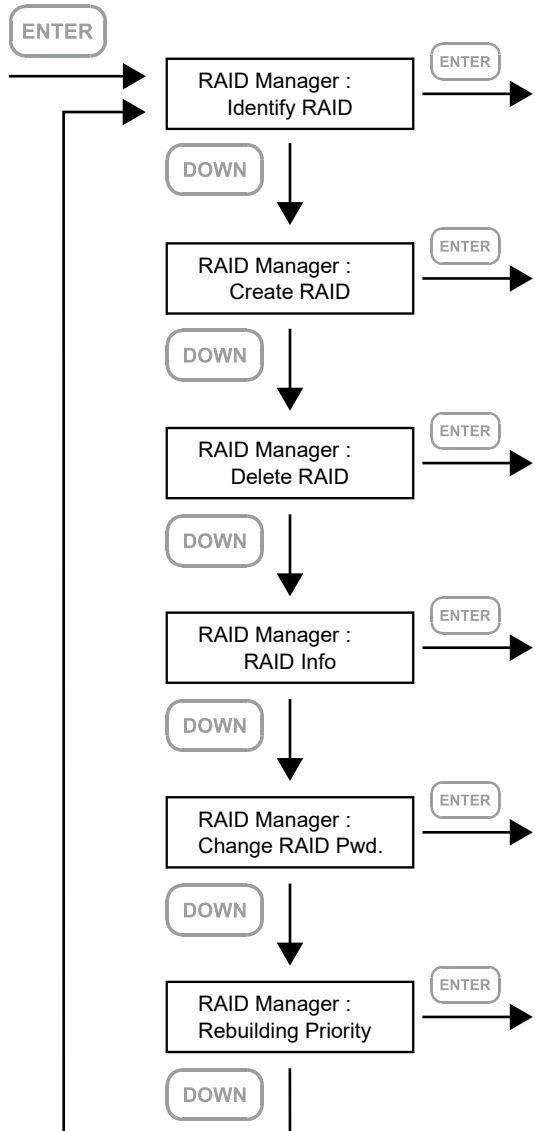
Level 1**Level 2**

Level 2

Level 3

Level 4

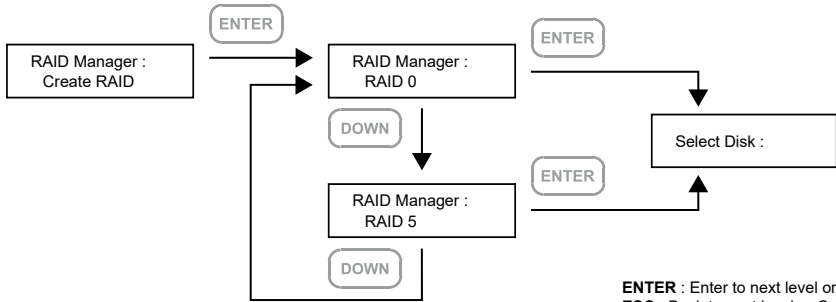
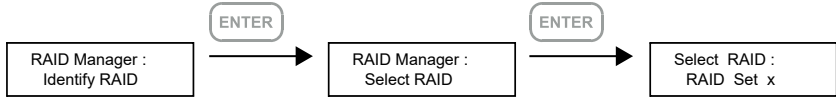

ENTER : Enter to next level or Confirm
ESC : Back to next level or Cancel
UP : Select HDD/SSD
DOWN : Cancel the select HDD/SSD

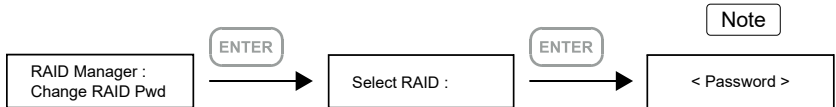
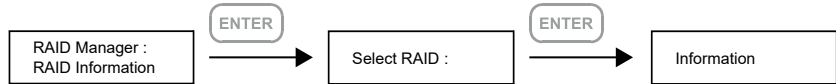
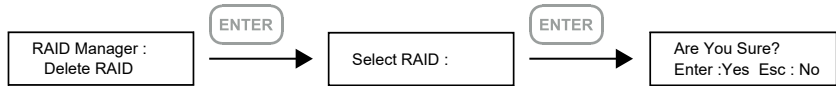

for RAID Setup

Note

Note 1. If you don't want to set password, please press "ENTER" to go to next step.
 Note 2. If user forgot the password, it will not be allowed to access the data from the storage or write new data into it. RAIDON will not be held liable for the damage or loss of data you stored on the storage.

Level 2

RAID Manager :
Rebuilding Priority

ENTER

Level 3

Select RAID :

ENTER

Level 4

Select Priority :
Medium Level

DOWN

Select Priority :
Low Level

DOWN

Select Priority :
Lowest Level

DOWN

Select Priority :
Highest Level

DOWN

Select Priority :
High Level

DOWN

Level 1

== Main Menu ==
System Manager

ENTER

Level 2

System Manager :
System Info.

ENTER

DOWN

System Manager :
Changhe Password

ENTER

DOWN

System Manager :
Logout From Menu

ENTER

DOWN

System Manager :
Alarm Control

ENTER

DOWN

System Manager :
Hardware Monitor

ENTER

DOWN

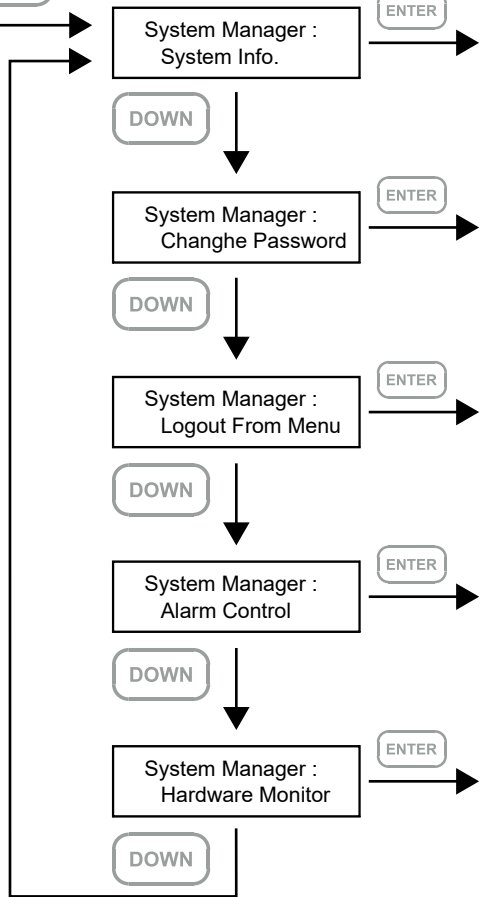

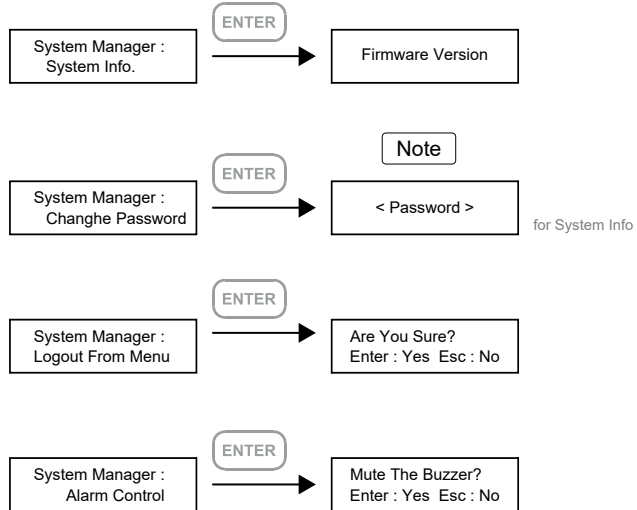
Level 3**Level 4**

Note 1. If you don't want to set password, please press "ENTER" to go to next step.

Note 2. If user forgot the password, it will not be allowed to access the data from the storage or write new data into it. RAIDON will not be held liable for the damage or loss of data you stored on the storage.

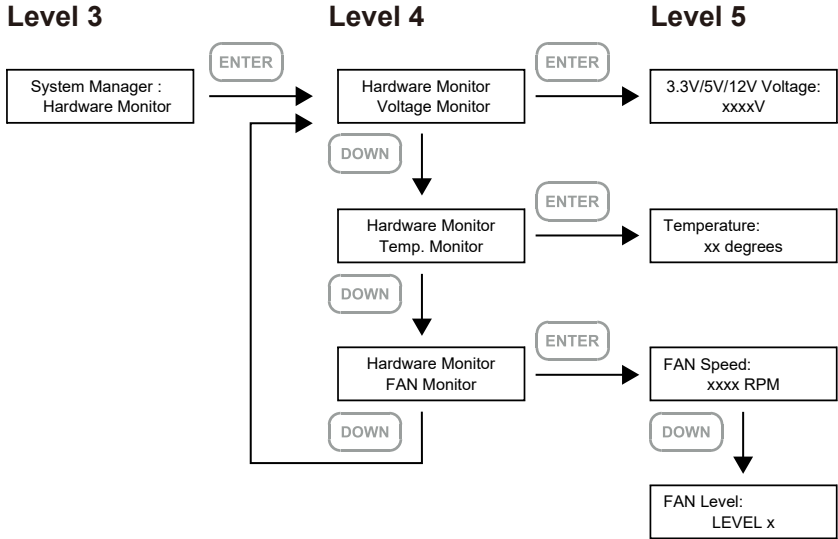

6. Support DisplayPort

1. The GR5640 offers a DisplayPort support DP1.1a, provides up to 4K@30Hz resolution, and is compatible with monitor and cables with DisplayPort.
2. By using third-party's DisplayPort adapter, it can be connected to the monitor with Mini DisplayPort interface.
3. By using third-party's active DisplayPort adapter, it can be connected to the monitor with VGA, DVI and HDMI interface.

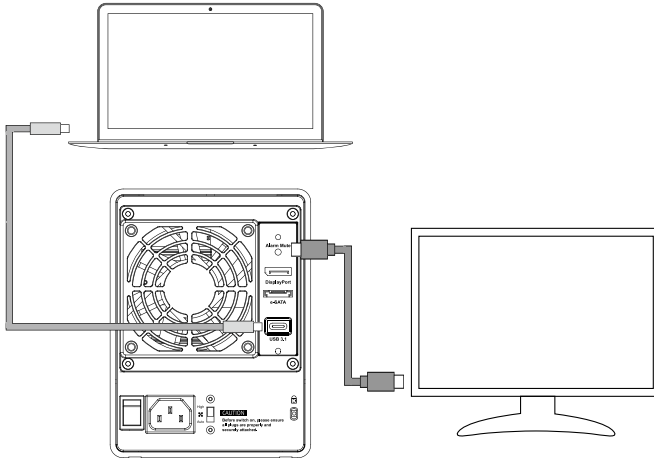

★ For DisplayPort (PD 1.1a) and USB Power Delivery (PD) functions, it needs to be used with a USB Type-C to C cable, and the host must support these functions.

7. Support USB Power Delivery (GR5640-SB31+/GR5640-SBA31+)

1. USB Power Delivery (USB-PD) introduces charging technology and unified cable standards. GR5640-SB31+/GR5640-SBA31+ supports USB-PD. Use **USB C to C cable**, it can provide up to 24W (5V/3A (15W), 9V/2A (18W), 12V/2A (24W)) power charging to the host.
2. If the connected host is a notebook that supports USB-PD (5V/9V/12V) charging, it will remain charging after the notebook is powered off or restarted while the GR5640-SB31+/GR5640-SBA31+ is still power on.
3. If the GR5640-SB31+/GR5640-SBA31+ cannot be recognized after the notebook restarted, please reconnect the **USB C to C cable** or restart the GR5640-SB31+/GR5640-SBA31+.

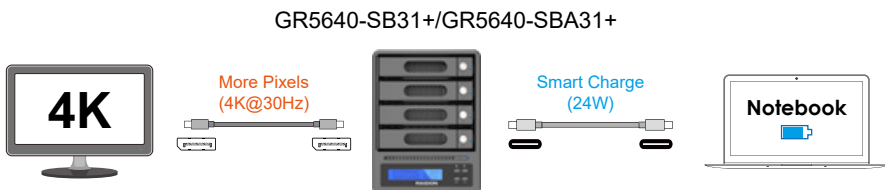

★ Notebook will need to support 5V/9V/12V charge.

8. Replacement of Malfunctioning Drive and Data Rebuild Instructions

When a front hard drive indicator has lit up red and the audio alarm sounds, this could mean the indicated hard drive may be malfunctioning. If this occurs, you may press the mute button at the rear of the system to shut off the audio alarm and power off the system immediately if in the allowed operational state, and then re-power on the system to double check and see if in fact the indicated hard drive has malfunctioned. If the problem persists, please turn off the system and follow the directions below :

1. Remove the drive tray containing the malfunctioned hard drive and disassemble the hard drive from drive tray.
2. Mount the new hard drive onto the tray and insert it back to the empty drive position of the GR5640, then push the latch into place making sure it is secured and locked.
3. In RAID 5 mode, when you turn the system on, the hard drive status indicator of the replacement drive will interchangeably blink red and purple to inform that the data is being rebuilt to the replacement drive. During data rebuild, you may operate the GR5640 as normal. When the indicator stops, the data rebuild process has been completed.

9. System Temperature Overheat and Fan Failure Management

If the alarm indicator has lit up red and the audio alarm sounds, this could mean that either a system fan has stopped operating entirely or the system temperature has exceeded over the default temperature of 55° C. When this occurs, you may press the mute button at the rear of the system to shut off the audio alarm and power off the system immediately if in the allowed operational state to let the system cool. Check and see if the overall operation environment is well ventilated and make sure there are no blockages to the enclosed fan and then re-power on the system to continue use. If the problem persists, please turn off the system and contact your supplier or the RAIDON tech support for further assistance.

10. Install The Operation System Into This Device

Install macOS (Use macOS Mojave 10.14 for example)

1. Need to have network online capabilities. If a wireless network is available, you can choose it from the Wi-Fi menu in the menu bar. This menu is also available in macOS Recovery.
2. Turn on your Mac and immediately press and hold Command (⌘)-R. Continue holding until you see the Apple logo or a spinning globe. Startup is complete when you see the utilities window:

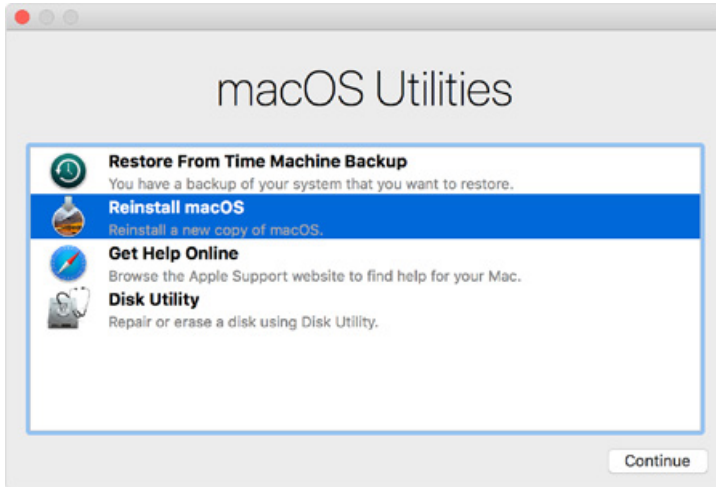

3. If you need to erase your disk before installing macOS, select Disk Utility from the Utilities window, then click Continue. You probably don't need to erase, unless you're selling or giving away your Mac or have an issue that requires you to erase.

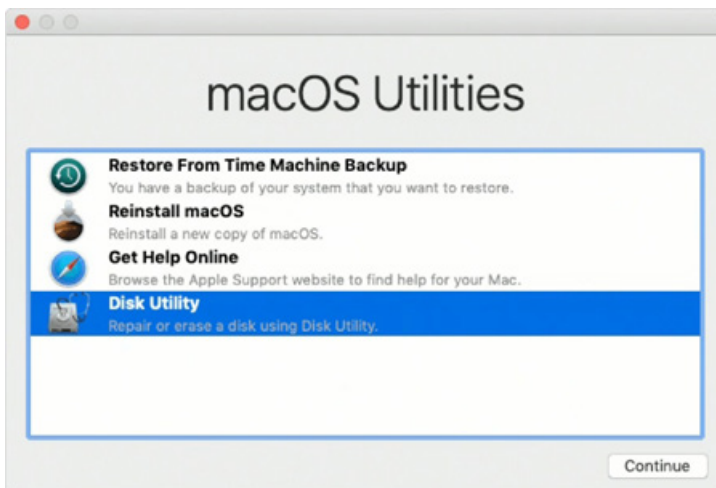

4. Install macOS. Choose Reinstall macOS from the Utilities window, and click continue.

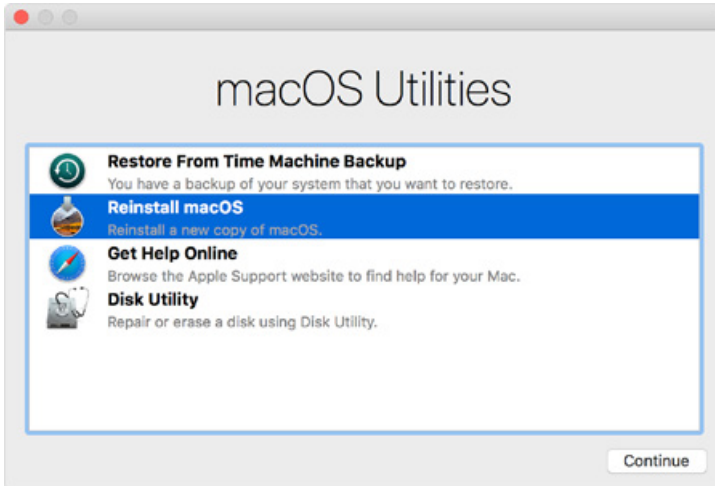

5. Follow the onscreen instructions, select agree to the software license agreement, and then select the disk to start the installation.



6. Please allow installation to complete without putting your Mac to sleep or closing its lid. During installation, your Mac might restart and show a progress bar several times, and the screen might be empty for minutes at a time.

Install Windows (Use Windows 10 Home Edition for example)

1. The following content is an example of using the software "WinToUSB Free Edition". For related specifications and copyrights, please refer to [the software official website](#) for details.
2. After the software is installed, press the shortcut icon of the desktop twice to open Hasleo WinToUSB.



3. On the left side of the interface, select "Mirror to USB" and click the right folder icon to select the ISO file for Windows 10.



4. Select the version of Windows you want to install and go to the next step.

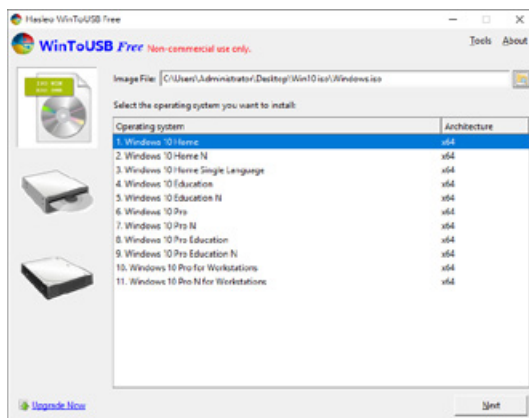

Note: WinToUSB Free Edition does not support Windows Professional and Enterprise editions.

5. Select the USB external drive to install.

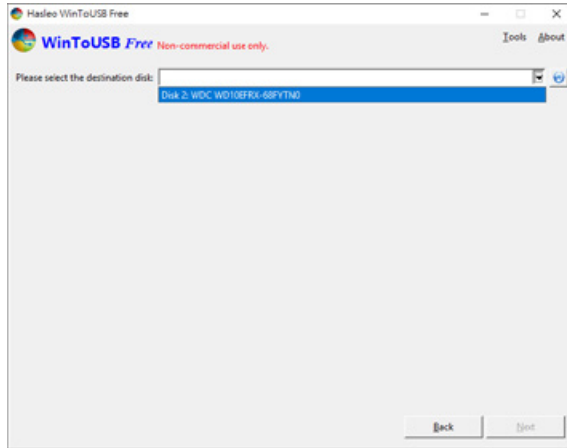

6. Select the version of the disk partition configuration according to your personal hardware specifications, then execute "Yes" to proceed to the next step.



7. Follow the default and follow the next step.

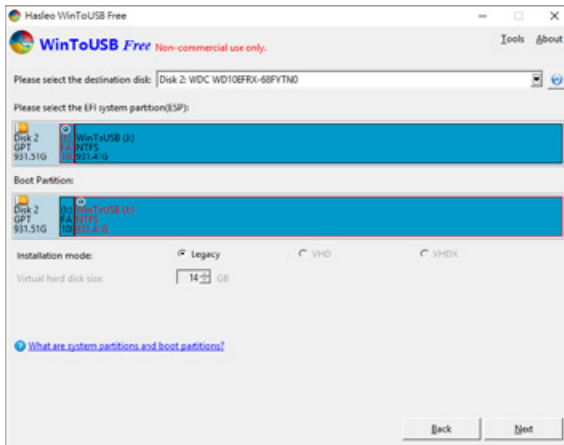

8. Windows 10 is installed to an external hard drive. After the installation is complete, click the "End" button, and then confirm to leave.

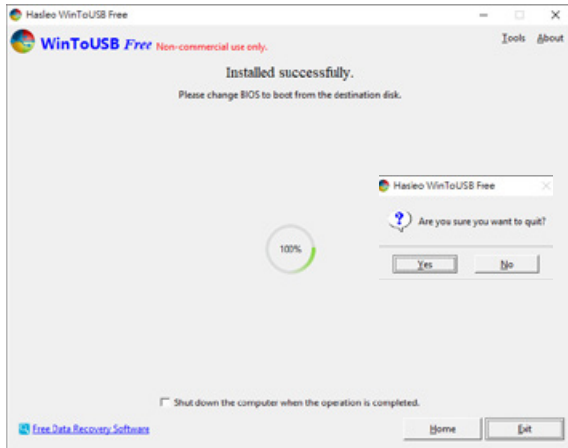

9. Confirm that the external hard disk is inserted in the USB slot of the computer. After rebooting, enter the BIOS or UEFI adjusts to the USB external hard disk box as the first boot sequence, and saves the settings and leaves.

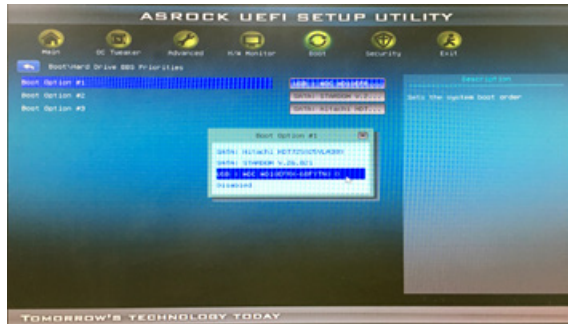

Note: The screenshot is for illustration only, and the actual situation varies depending on each motherboard.

10. Then start the installation process for Windows 10, and follow the system instructions and personal requirements to complete the setup.

11. Frequently Asked Questions

Q1. Which drive format should I choose to format the hard drives in the GR5640?

A: It depends on the computer system you most often use. See the below suggestions:

1. Use NTFS format for Windows 2000/XP/Vista/7/8/10 system
2. Use HFS+ (Mac OS Extended) format for a Mac OS X system
3. Choose FAT32 format if you'll use the GR5640 in both Windows and Mac environments (the maximum size of one single file may not exceed 4 GB).

Q2. Why can't my GR5640 reach the transfer performance speed of 200 MB/s via e-SATA interface as stated on your website?

- A: 1. Please first check if your PCI-E SATA host adapter would only support PCI-E (1X). This type of host adapters cannot reach the transfer performance speed beyond 135MB/s.
2. The GR5640 will need to be set to the RAID 0 mode also.

關於這份手冊

感謝您使用 RAIDON 的產品。本手冊將介紹 RAIDON GR5640 產品。在您開始使用 RAIDON GR5640 產品前，建議您先閱讀過本手冊。手冊裡的資訊在出版前雖已被詳細確認，實際產品規格仍將以出貨時為準；任何產品規格或相關資訊更新請您直接到 www.RAIDON.com.tw 網站查詢，本公司將不另行通知。若您想獲得 RAIDON 最新產品訊息、使用手冊、韌體，或對 RAIDON 產品有任何疑問，請您聯絡當地供應商或到 www.RAIDON.com.tw 取得相關訊息。

本手冊相關產品內容歸銳銳科技股份有限公司版權所有

1. 環境需求

工作溫度：0 ~ 40 °C (32 ~ 104 °F)

儲存溫度：-20 ~ 47 °C (-4 ~ 116 °F)

相對濕度：5% 至 95% 非冷凝狀態

工作電壓：100~240V AC

2. 產品外觀及包裝內容

打開包裝外盒後，包裝內容應包含下列組件：

GR5640-SBA31+ 本體 X1 (內含抽取盒 x4)	GR5640-SB31+ 本體 X1 (內含抽取盒 x4)	GR5640-SB31A 本體 X1 (內含抽取盒 x4)
USB 3.2 C to C 連接線 x1	USB 3.2 C to C 連接線 x1	— —
USB 3.2 C to A 連接線 x1	— —	USB 3.2 C to A 連接線 x1
e-SATA 連接線 x1	e-SATA 連接線 x1	e-SATA 連接線 x1
電源線 x1	電源線 x1	電源線 x1
快速安裝導引 x 1	快速安裝導引 x 1	快速安裝導引 x 1
螺絲及頂針	螺絲及頂針	螺絲及頂針

- 請確認相關配件與產品本身是否有受損或配件缺少，若有任何疑問請與本產品供應商聯絡。
- 請前往官網 - 產品資料下載頁面 (<https://www.RAIDON.com.tw/RAIDON2016/download.php>) 下載驅動程式以及其餘相關資源。

正面與背面示意圖

正面圖

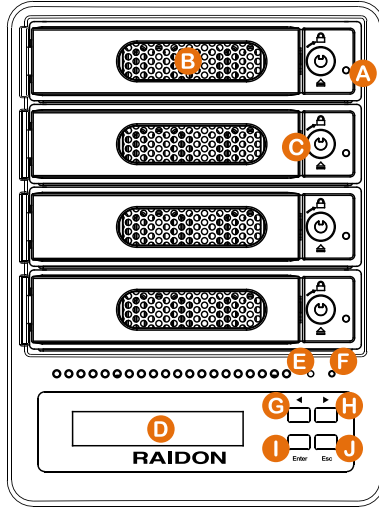

- A. 硬碟讀取燈
- B. 硬碟抽取盒把手
- C. 硬碟抽取盒鑰匙孔
- D. 液晶顯示器
- E. 系統指示燈
- F. 電源指示燈
- G. UP 按鍵
- H. DOWN 按鍵
- I. ENTER 按鍵
- J. ESC 按鍵

背面圖

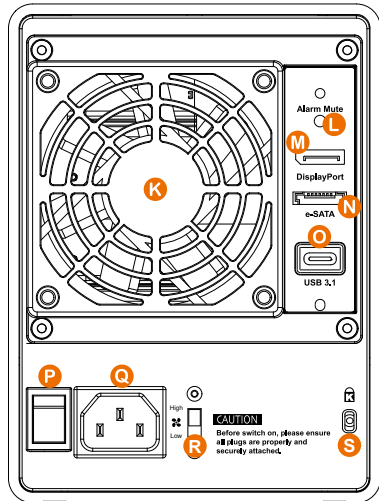

- K. 風扇
- L. 靜音開關
- M. Display 埠
- N. e-SATA 連接埠
- O. USB 3.1 連接埠
- P. 電源總開關
- Q. 電源插座
- R. 風扇轉速切換按鈕
- S. 防竊鎖孔

燈號一覽表：

狀態	電源指示燈	系統指示燈	硬碟狀態顯示燈		蜂鳴器	
			RAID	JBOD	RAID	JBOD
無硬碟	藍燈恆亮	— —	— —		— —	
資料存取	藍燈恆亮	— —	藍燈閃爍		— —	
硬碟閒置	藍燈恆亮	— —	藍燈恆亮		— —	
資料重建 - 來源碟	藍燈恆亮	— —	藍燈閃爍	— —	— —	
資料重建 - 資料碟	藍燈恆亮	— —	紫燈閃爍	— —	— —	
風扇故障	藍燈恆亮	紅燈恆亮	藍燈恆亮		YES	
過熱 $\geq 50^{\circ}\text{C}$	藍燈恆亮	紅燈恆亮	藍燈恆亮		YES	

3. 硬體需求與注意事項

- 當系統運作時，請勿任意移除任何一顆硬碟，以免導致資料遺失。
- 完成系統初始化安裝後，在使用上請勿任意變更硬碟位置；此動作將可能導致系統無法形成 RAID。
- 在新增或變更 RAID 模式後需重新啟動產品，以確保完成更新為新的 RAID 模式。
- 當支援 USB PD 功能的 Notebook 僅連接 GR5640-SB31+/GR5640-SBA31+ 時，GR5640-SB31+/GR5640-SBA31+ 可以提供最多 24W (12V/2A) 的電源供應，但後續再接上原本 Notebook 的電源供應器時，主要供電來源將由 Notebook 自行判斷，以可供應較大瓦數的電源為主，此時的 GR5640-SB31+/GR5640-SBA31+ 有可能會因此中斷供電並重新被 Notebook 辨識，因此當要接上其它電源時，請務必先確認當下 GR5640-SB31+/GR5640-SBA31+ 並沒有資料存取的動作。
- GR5640-SB31+/GR5640-SBA31+ 的 PD 功能，最多僅能提供 24W，主要在延長 Notebook 的使用時間，與原本 Notebook 電源供應器的瓦數有落差，以 Macbook Pro 13" 為例，電源供應器為 60W，假設使用原本的電源供應器充電需要 2 小時，透過 GR5640-SB31+/GR5640-SBA31+ 大約會需要 3 倍的時間。因此如果需要長時間使用 Notebook，建議先接上 Notebook 原本的電源供應器後再接上 GR5640-SB31+/GR5640-SBA31+。
- 當您需要關閉或移除 GR5640 時，務必透過您所操作的作業系統中執行硬碟安全移除後，方進行電源關閉的動作。
- 強烈建議除了使用 GR5640 的資料儲存功能外，請針對重要資料備份到另一個儲存裝置上或遠端備份，雙重備援您重要的資料。若您儲存在 GR5640 的資料損毀或遺失，RAIDON 不負任何的責任。

4. 硬體安裝

請參照以下步驟完成硬體安裝

1. 將主機置放於平穩空間上，並確認散熱風扇沒有被擋住，且四周有適當的散熱空間。（請避免接近水源或是其他容易造成產品損傷的環境）
2. 請使用零件包內附的鑰匙插入鑰匙孔向左轉 90 度，輕按鎖頭抽取盒門將會輕彈開啟，即可將硬碟抽取盒取出。



3. 安裝 3.5 吋硬碟，請使用 6 顆零件包內附的大顆螺絲加以固定；安裝 2.5 吋硬碟，請使用 4 顆零件包內附的小顆螺絲加以固定。

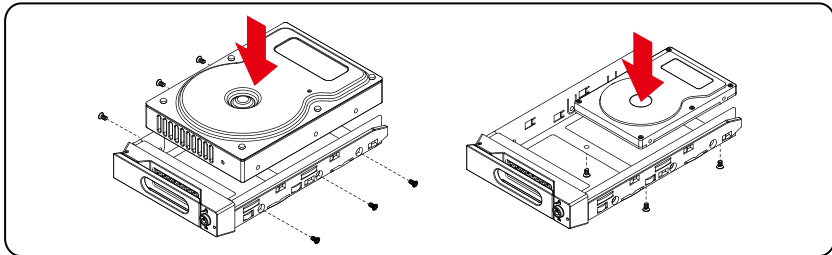

注意：不建議使用不同廠牌，或是同廠牌不同型號的硬碟，避免影響效能。

4. 硬碟安裝完成後，請將抽取盒平移放入主機內，並關上把手。
5. 將電源線與 GR5640 連接，再將電源線與電源插座連接，執行開機。
6. 透過前方的 LCD 與按鍵來設定您所需求的儲存模式。（請參考 " 前面板操作及 LCD 訊息說明 "）
7. 將附件中的連接線分別接到 PC 與 GR5640 的相關連接埠。
8. 開機後，您的作業系統將會自動辨識到 RAID 容量；待辨識成功後，請依據您所需的儲存格式，將系統內的硬碟依照作業系統的指示完成格式化。待格式化完成後，便可直接執行 RAID 系統。

5. 前面板操作及 LCD 訊息說明

前面板操作：

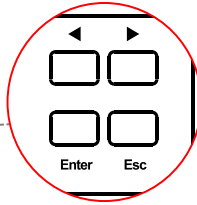
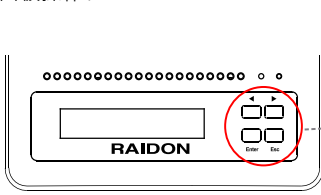

Enter：進入下一層 或是 確認
Esc：跳回上一層 或是 取消
Up / Down：循序選擇項目

- 使用者可經由 LCM 顯示螢幕進行 RAID 設定，GR5640 預設值為 JBOD，可進入 Quick Setup 快速設定成其他 RAID 模式使用。
- 如需進行其他設定，則可參考下列 LCD 說明進行操作：

Level 0	Level 1	Level 2	Level 3	Level 4		
External 4BAY HARDWARE RAID	Quick Setup	Create One RAID	RAID 0 / RAID 5	Select Disk		
		Delete All RAID				
	Disk Manager	Identify Disk	Disk 1	Check Disk LED		
			Disk 2	Check Disk LED		
			Disk 3	Check Disk LED		
			Disk 4	Check Disk LED		
		Show Disk Info	< Disk Info >			
	RAID Manager	Identify RAID	Select RAID			
		Create RAID	RAID 0 / RAID 5	Select Disk		
		Delete RAID	Select RAID			
		RAID Info	— —			
		Change RAID Pwd	< Password > for RAID Setup			
		Rebuilding Priority	Highest/High/Medium/Low/Lowest			
	System Manager	System Info	Firmware Version			
		Change Password	< Password > for System Info			
		Logout From Menu	< Y or N >			
		Alarm Control	Mute the Buzzer			
		Hardware Monitor	Voltage Monitor	< 3.3V / 5V / 12V >		
			Temp. Monitor	< Temp. >		
	Fan Monitor		< Fan Speed / Fan Level >			

以下為首次設定的顯示流程：

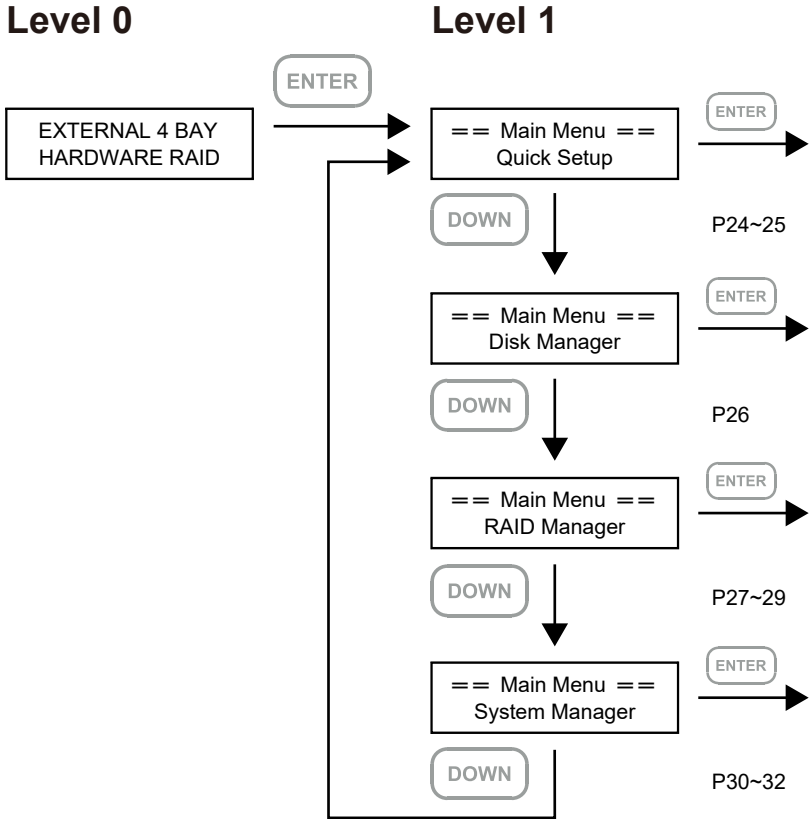

Level 1

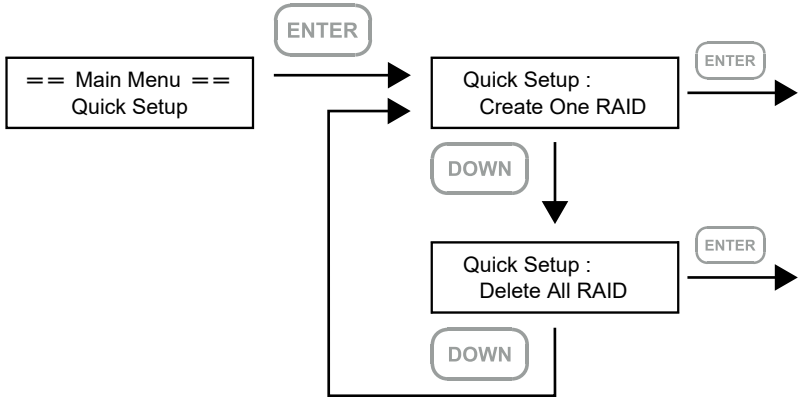

Level 2

Level 2

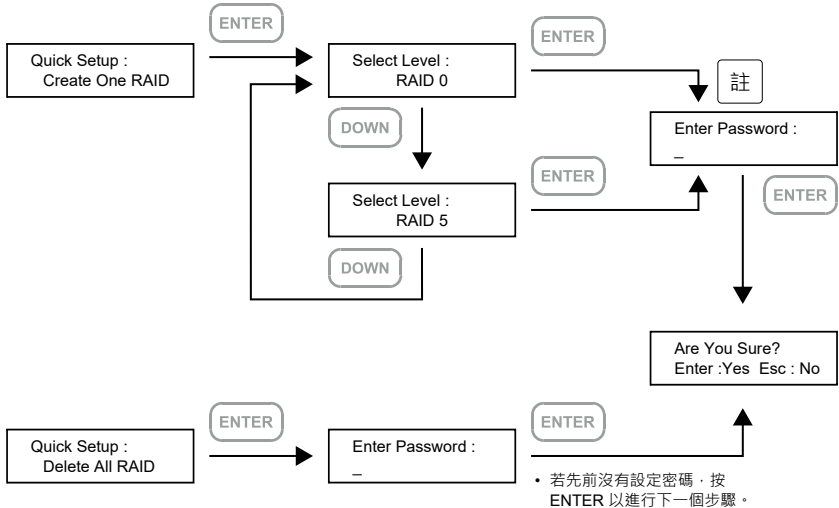

Level 3

Level 4

註 1. 可以不設定密碼，按 ENTER 以進行下一個步驟。

註 2. 如果使用者忘記密碼，將無法讀取硬碟上的資料，或是將新資料寫入硬碟。若使用者儲存在 GR5640 的資料損毀或遺失，RAIDON 將不負任何的責任。

Level 1

== Main Menu ==
Disk Manager

ENTER

Level 2

Disk Manager :
Identify Disk

ENTER

DOWN

Disk Manager :
Show Disk Info

ENTER

DOWN

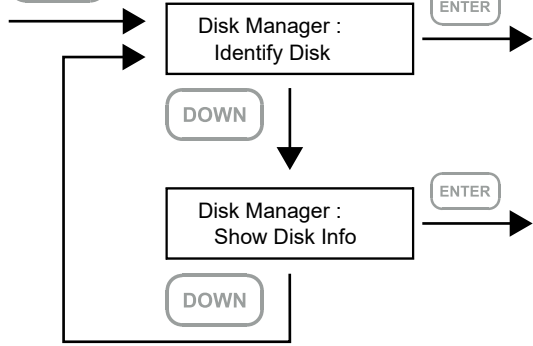

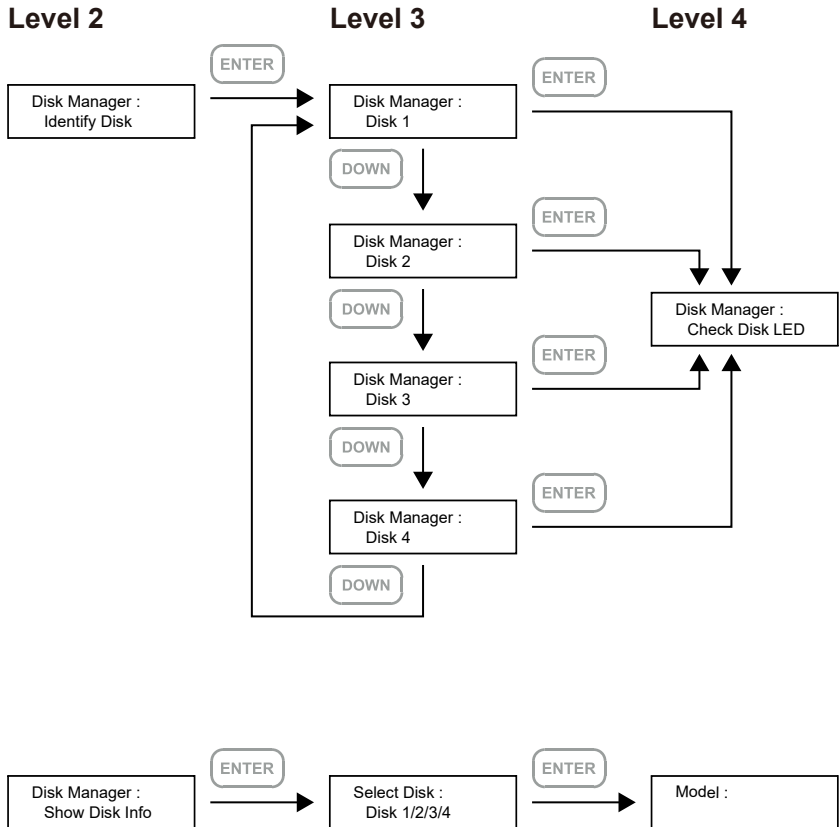

Level 1

== Main Menu ==
RAID Manager

Level 2

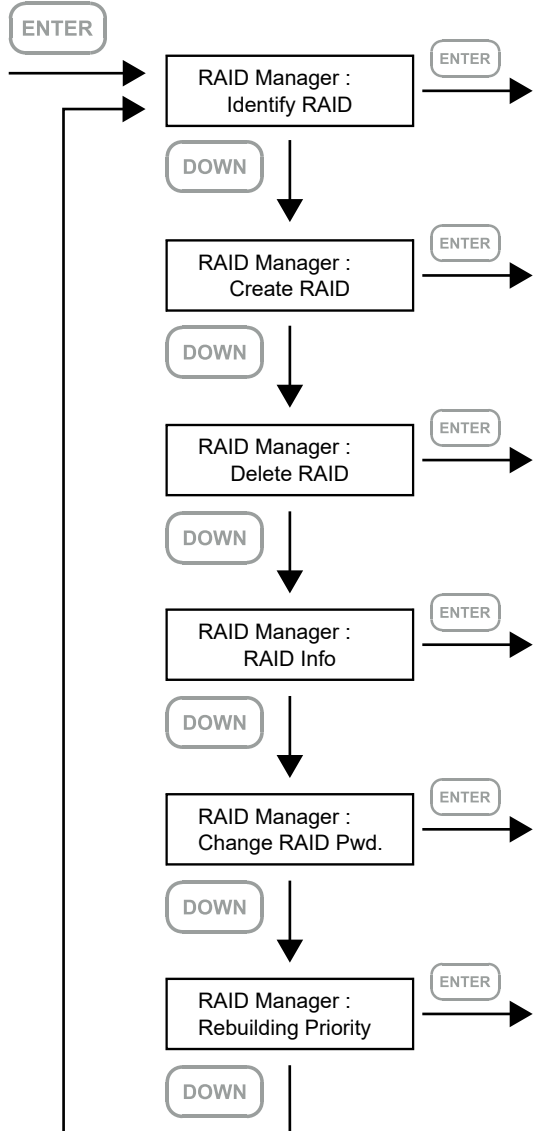

Level 2

Level 3

Level 4

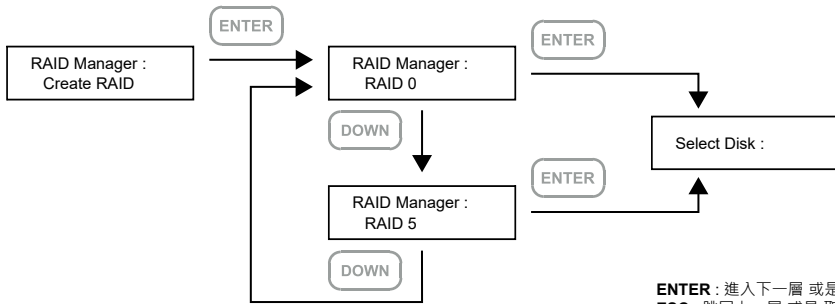
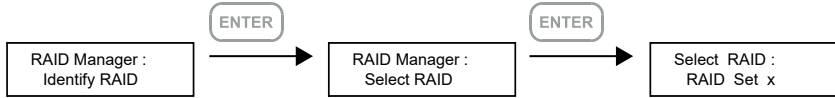

ENTER : 進入下一層 或是 確認
ESC : 跳回上一層 或是 取消
UP : 指定硬碟
DOWN : 取消被指定硬碟

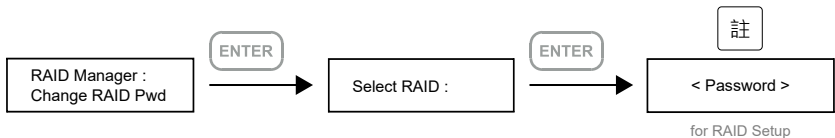
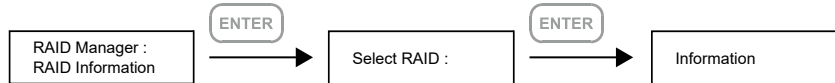
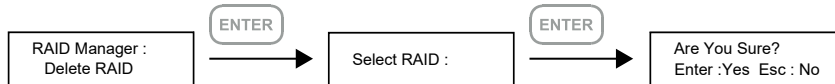

註 1. 可以不設定密碼，按 ENTER 以進行下一個步驟。

註 2. 如果使用者忘記密碼，將無法讀取硬碟上的資料，或是將新資料寫入硬碟。若使用者儲存在 GR5640 的資料損毀或遺失，RAIDON 將不負任何的責任。

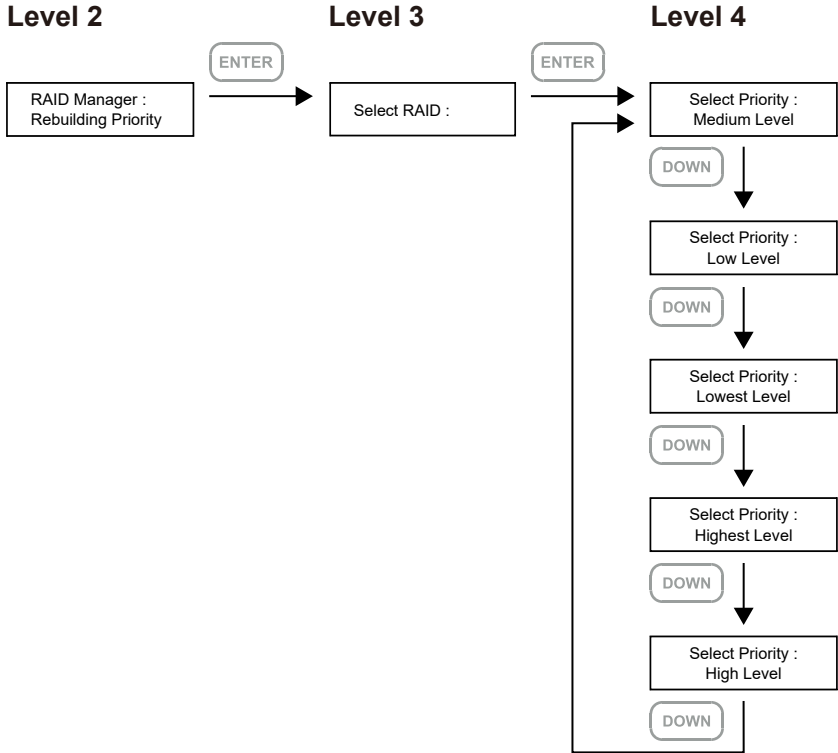

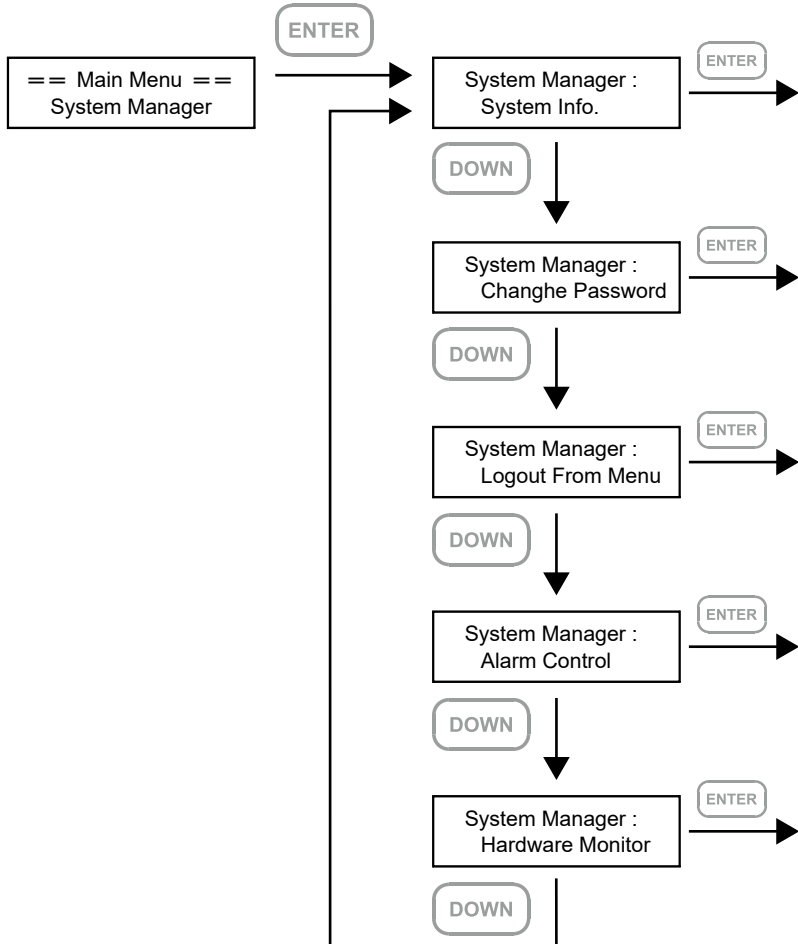
Level 1**Level 2**

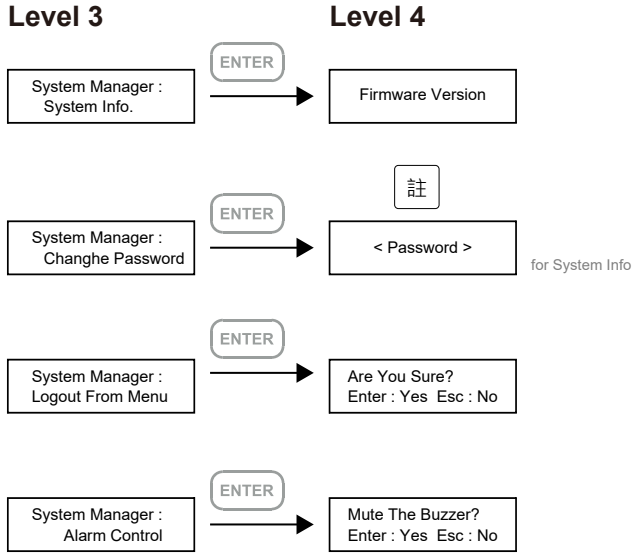

註 1. 可以不設定密碼，按 ENTER 以進行下一個步驟。

註 2. 如果使用者忘記密碼，將無法讀取硬碟上的資料，或是將新資料寫入硬碟。若使用者儲存在 GR5640 的資料損毀或遺失，RAIDON 將不負任何的責任。

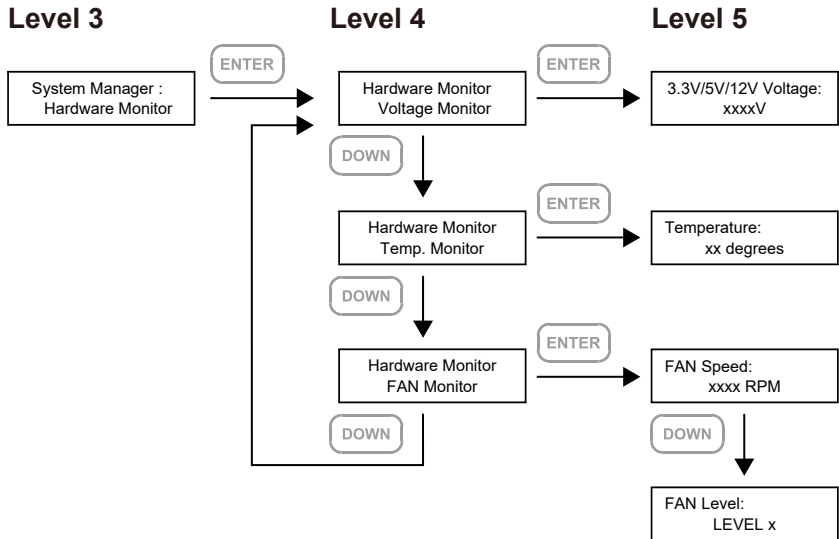

6. 支援 Display 埠

1. GR5640 提供一個 Display 埠支援 DP1.1a，最高可支援 4K@30Hz 畫質，相容於具有 Display 埠的螢幕及連接線。
2. 透過第三方 Display 埠轉接器或轉接線，可以連接具備 Mini Display 埠的螢幕。
3. 透過第三方主動式 Display 埠轉接器或轉接線，可以連接具備 VGA、DVI 或 HDMI 的螢幕。

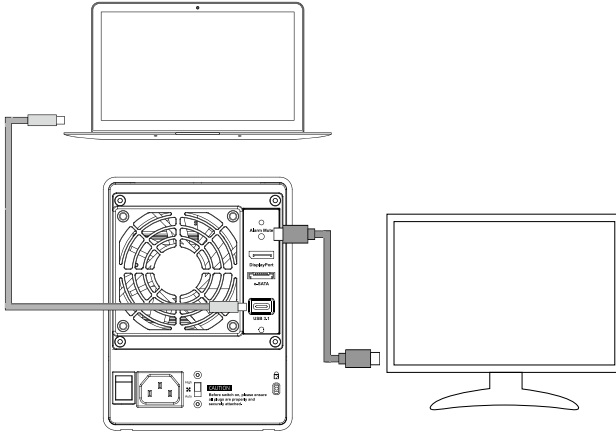

★ 對於 DisplayPort (PD 1.1a) 和 USB Power Delivery (PD) 功能，需要與 USB Type-C to C cable 一起使用，且主機必需支援這些功能。

7. 支援 USB Power Delivery (GR5640-SB31+/GR5640-SBA31+)

1. USB Power Delivery (簡稱 USB-PD)，為 USB 開發者論壇 (USB-IF) 推出快速充電技術與統一連接線標準。GR5640 支援 USB-PD，若採用 **USB C to C 連接線**，可提供 5V/3A (15W), 9V/2A (18W), 12V/2A (24W) 電力給主機端。
2. 若所連接之主機端為支援 USB-PD(5V/9V/12V) 充電的筆記型電腦，在 GR5640-SB31+/GR5640-SBA31+ 開機的狀態下，將筆電關機或重新開機後，USB-PD 仍會維持充電功能。
3. 如電腦無法讀取到 GR5640-SB31+/GR5640-SBA31+，請重新連接 **USB C to C 連接線**，或是將 GR5640-SB31+/GR5640-SBA31+ 關機再啟動，方可正常連接使用。

GR5640-SB31+/GR5640-SBA31+



★ 筆記型電腦需要支援 5V/9V/12V 充電。

8. 故障硬碟更換步驟及資料重建功能說明

1. 取出故障硬碟所存放的抽取盒，再將硬碟從抽取盒上拆解下來。
2. 將新的硬碟安裝至抽取盒後，再將新硬碟的抽取盒插回 GR5640 空的硬碟槽位置，並將抽取盒門鎖上，確認硬碟已完全插入。
3. RAID 5 模式下，將電源打開時，您將會看到所更換的新硬碟抽取盒旁的指示燈號呈現閃爍紅藍燈的狀態，表示更換上的硬碟資料正在進行重建；此時，您仍可正常使用 GR5640 工作；待資料重建指示燈號停止，即代表資料重建完成。RAID 0 模式下，因單顆硬碟故障會造成所有資料損毀，更換新硬碟後，請重新將系統內的硬碟格式化。

9. 系統過熱與風扇故障狀況排除

GR5640 內建故障警示功能，若 GR5640 內部溫度超過 55°C，或 GR5640 風扇發生故障時，內建的蜂鳴器會發出警告聲響，前面板的紅色警示燈號也會亮起；此時您可選按系統背面的靜音按鈕，先將警示聲關閉，並在允許的狀況下關閉 GR5640 電源讓系統降溫；同時，請先確認積體擺放環境是否通風良好，沒有任何物體擋住風扇孔，一併檢查 GR5640 的風扇是否停止運轉；待上述檢查確認後，再將電源開啟繼續使用本系統。若問題還是無法獲得解決，請與供應商或 RAIDON 聯絡，以便取得進一步的支援。

10. 外接磁碟安裝作業系統

安裝 macOS (以 10.14 Mojave 為例)

1. 需具備網路連線能力。若有無線網路可用，可以從選單列的 Wi-Fi 選單中選擇該網路。「macOS 復原」也提供這份選單使用。
2. 開啟 Mac 並立即按住 Command(⌘)-R，持續按住這些按鍵，直到出現 Apple 標誌或旋轉的地球。看到工具程式視窗，即表示完成啟動：



3. 若必須在安裝 macOS 之前清除磁碟，請從「工具程式」視窗選擇「磁碟工具程式」，然後按一下「繼續」。您可能不需要清除磁碟，除非要將 Mac 賣或送給別人，或是有問題需要清除磁碟。



4. 安裝 macOS · 在「工具程式」視窗中，選擇「重新安裝 macOS」，按一下「繼續」。



5. 按照螢幕上的指示，選擇同意軟體許可協議，然後選擇磁碟，開始安裝。



6. 請不要讓 Mac 進入睡眠或關上上蓋，以利安裝程序順利完成。安裝期間，Mac 可能會重新啟動並顯示進度列好幾次，而螢幕畫面也可能會一次空白幾分鐘時間。

安裝 Windows (以 Windows 10 家庭版為例)

1. 以下內容為使用工具軟體「WinToUSB 免費版」作為範例，相關規範與版權請到[軟體官網](#)詳閱說明。
2. 軟體安裝後，連續按兩下桌面的捷徑圖示，開啟 Hasleo WinToUSB。



3. 在界面左方選擇「鏡像到 USB」，再點選右方資料夾圖示來選擇 Windows 10 的 ISO 檔。



4. 選擇要安裝的 Windows 版本，執行下一步。

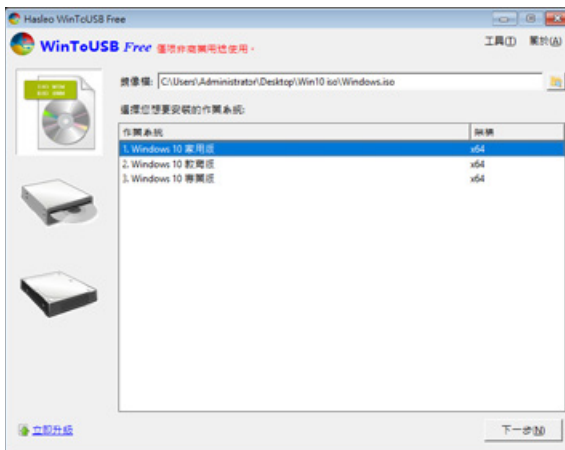

註：WinToUSB 免費版不支援 Windows 專業版與企業版。

5. 選擇要安裝的 USB 外接硬碟。

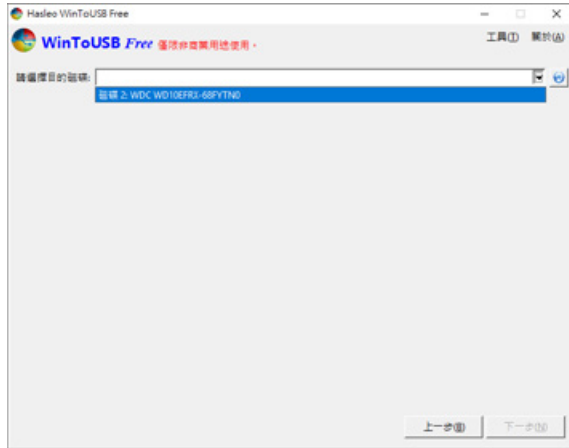

6. 依照個人硬體規格選擇磁碟分割配置的版本，之後執行「是」進行下一個的步驟。



7. 依照預設值，執行下一步。

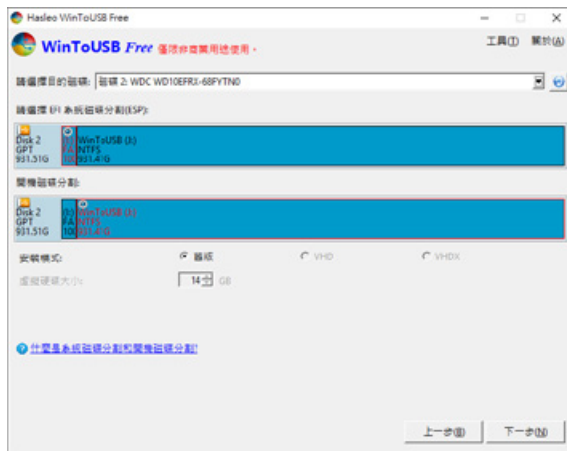

8. Windows 10 安裝到外接硬碟，待安裝完成後點選「結束」按鈕，之後再確認離開。



9. 確認外接硬碟插在電腦的 USB 插槽，重新開機後，進入 BIOS 或是 UEFI 調整成 USB 外接硬碟盒為第一開機順序，儲存設定後離開。

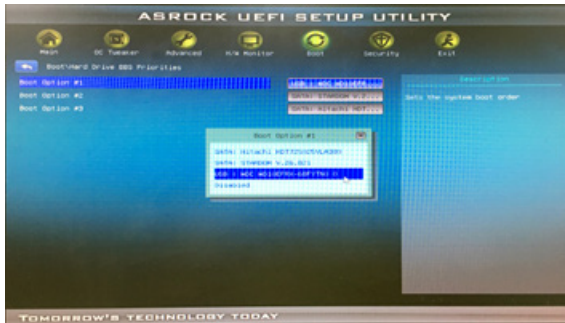

註：截圖僅為示意，實際情況依各家主機板而有所不同。

10. 接著開始進入 Windows 10 的安裝過程，請依系統指示以及個人需求完成設定。

11. 常見問題

Q1. 我應該選擇何種模式來格式化 GR5640 產品內的硬碟？

A：這將取決於您平常所使用的電腦系統，我們有以下建議：

1. Windows 2000 / XP / Vista / 7 / 8 / 10 使用 NTFS
2. Mac OS X 使用 HFS+ (Mac OS Extended)
3. 如必須同時使用於 PC 或 Mac，請使用 FAT32 (單一檔案的最大限制是 4GB)

Q2. 為什麼我所購買的 GR5640 透過 e-SATA 介面無法達到 200MB/s 以上的傳輸速度？

A：1. 請先檢查您所購置的 PCI-E SATA 擴充卡是否僅支援 PCI-E (1X)，此類擴充卡無法達到 135MB/s 以上的傳輸速度。
2. GR5640 的儲存模式必須為 RAID 0 或 RAID 5 模式。

RAIDON
Your Data Security Guardian
www.raidon.com.tw